

AYDINLANMA SONRASI/SANAYİ DEVRİMİ ÖNCESİ

HER DAİM

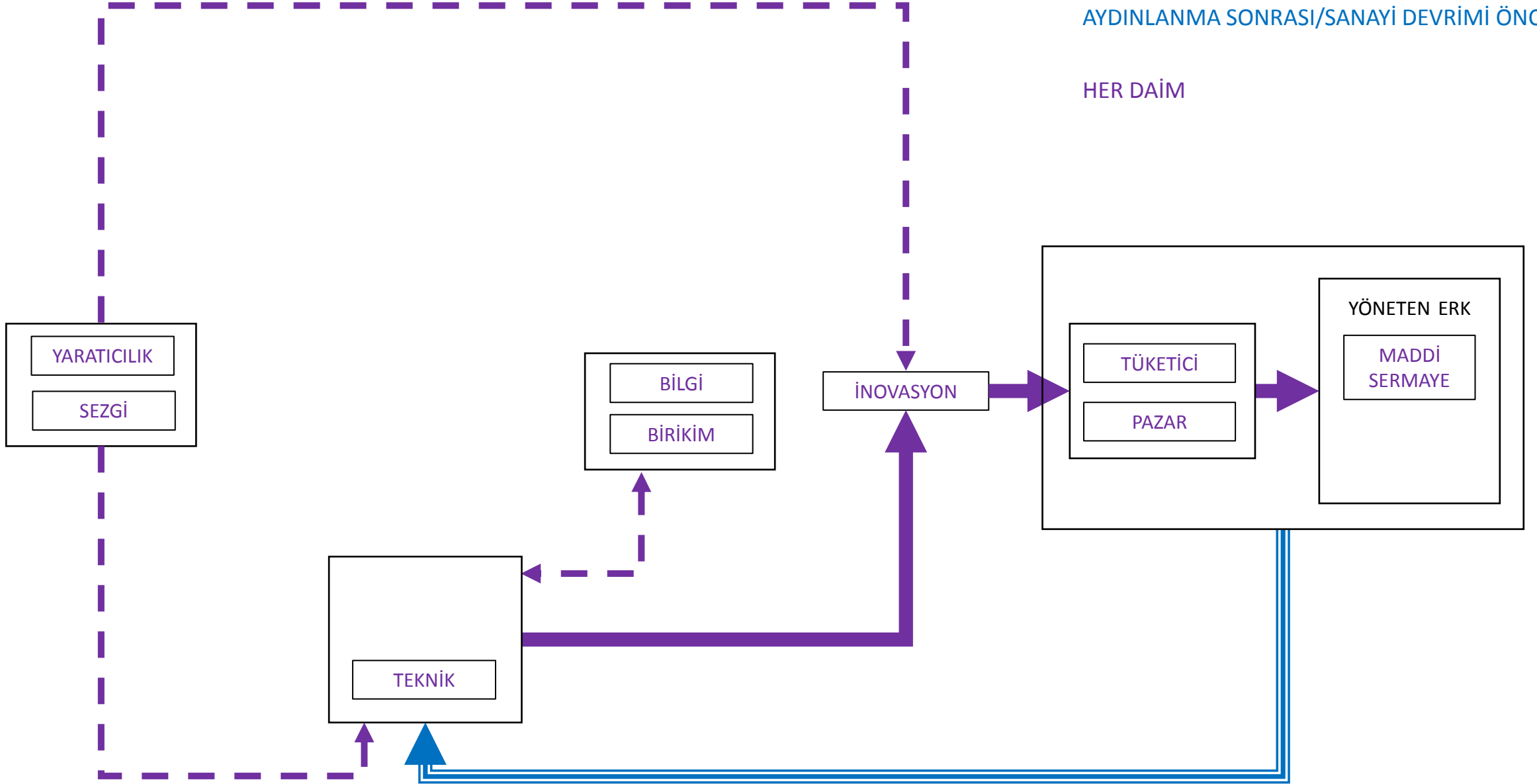

AYDINLANMA SONRASI/SANAYİ DEVRİMİ ÖNCESİ

HER DAİM

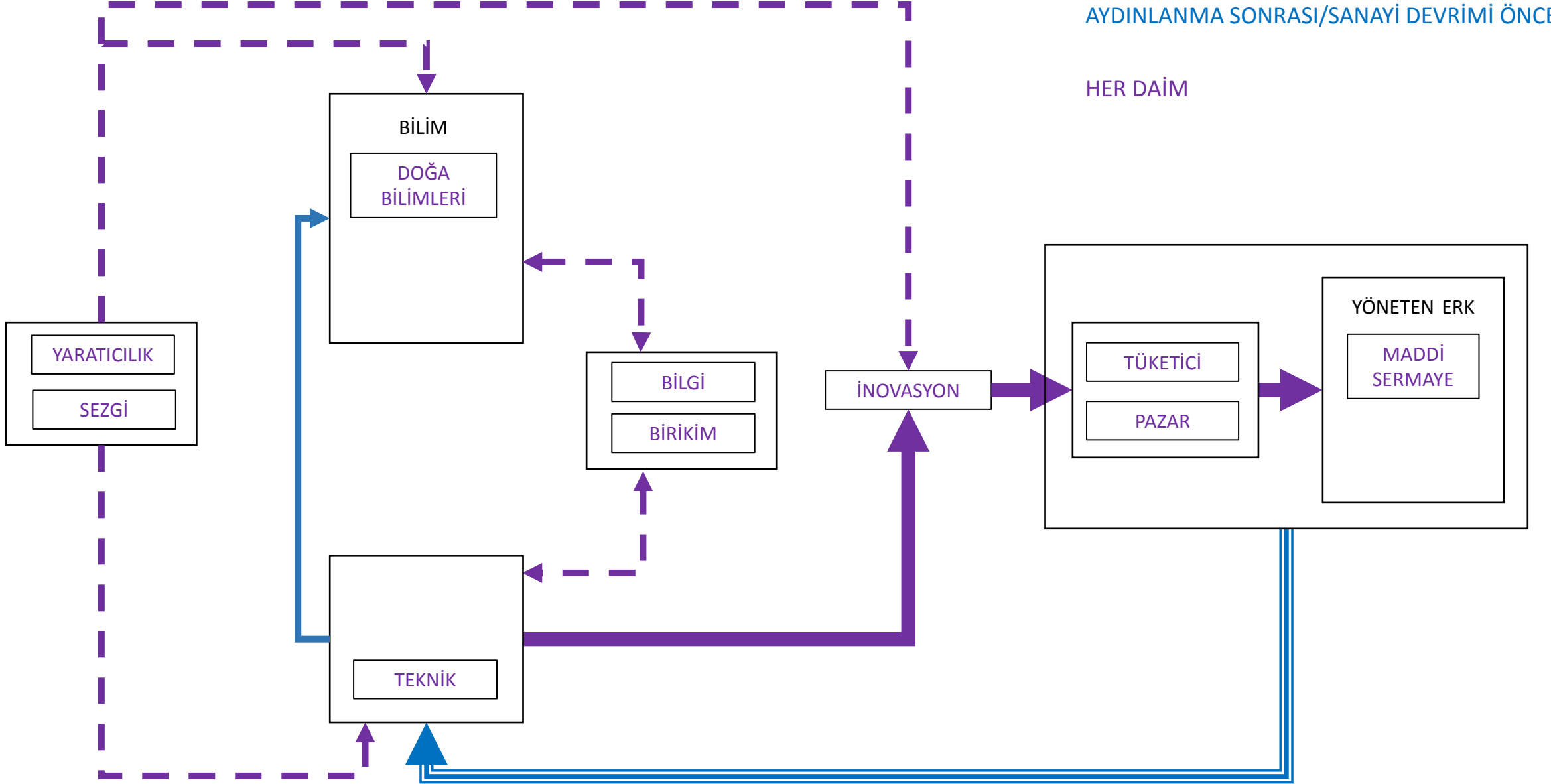

AYDINLANMA SONRASI/SANAYİ DEVRİMİ ÖNCESİ

HER DAİM

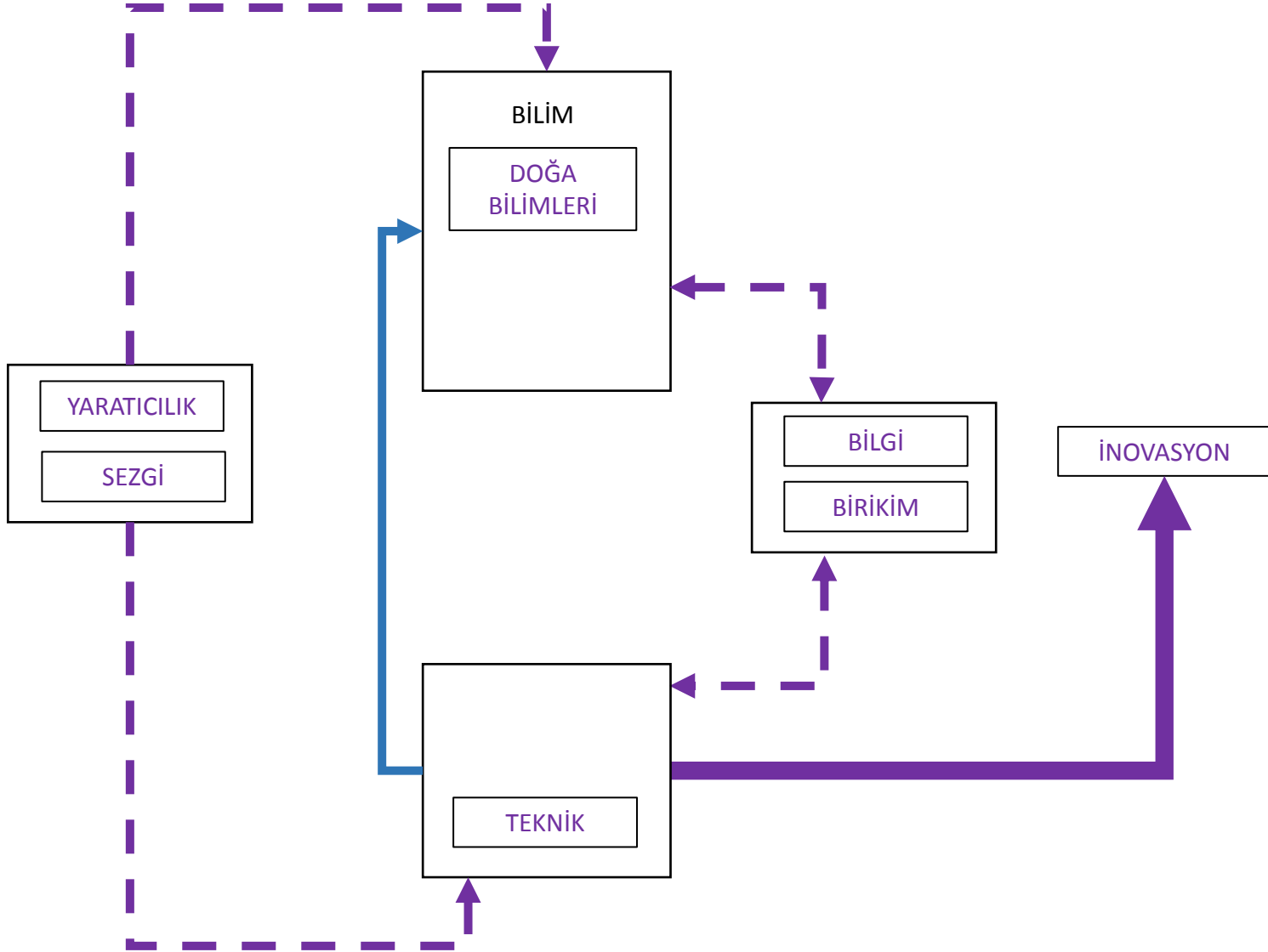

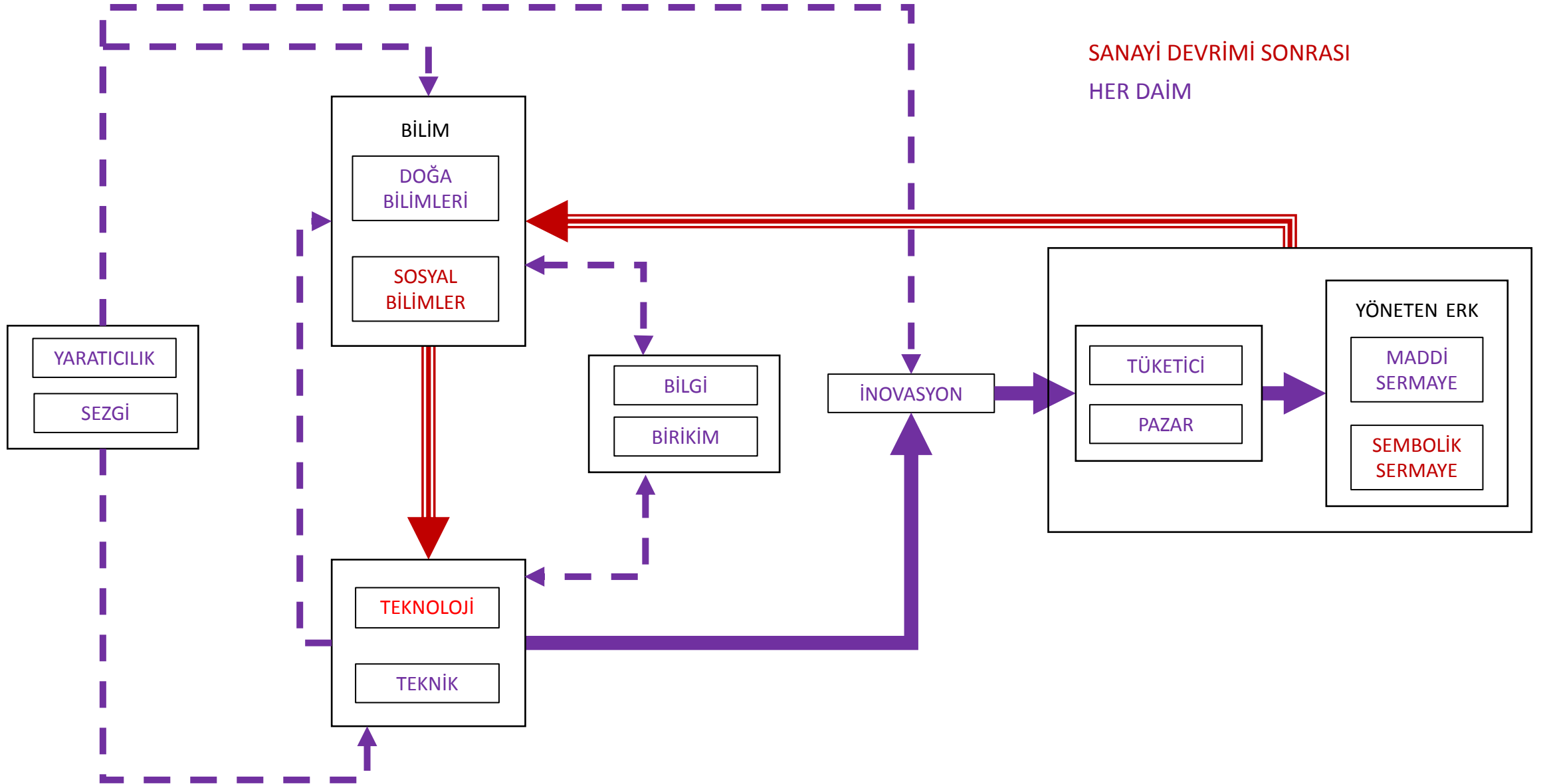

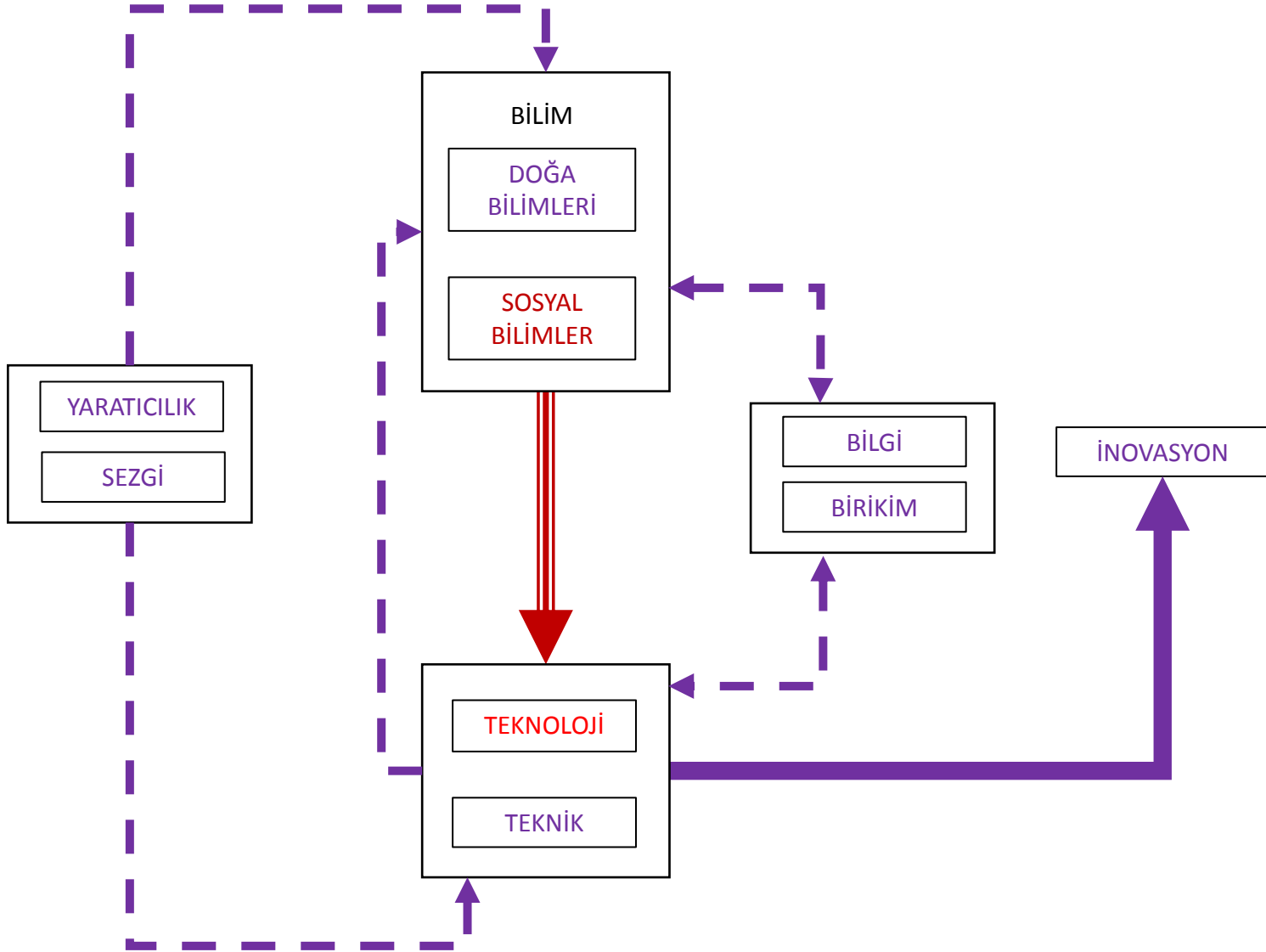

SANAYİ DEVRİMİ SONRASI

HER DAİM

AYDINLANMA SONRASI/SANAYİ DEVRİMİ ÖNCESİ
SANAYİ DEVRİMİ SONRASI
HER DAİM

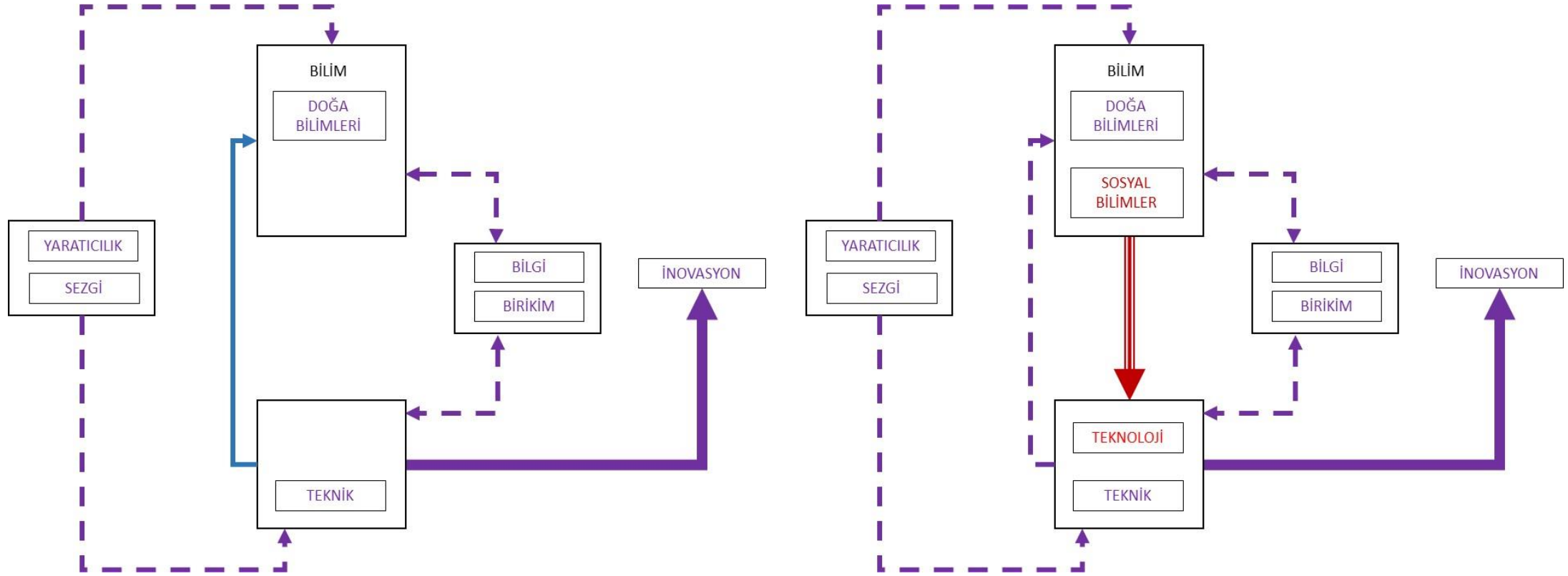

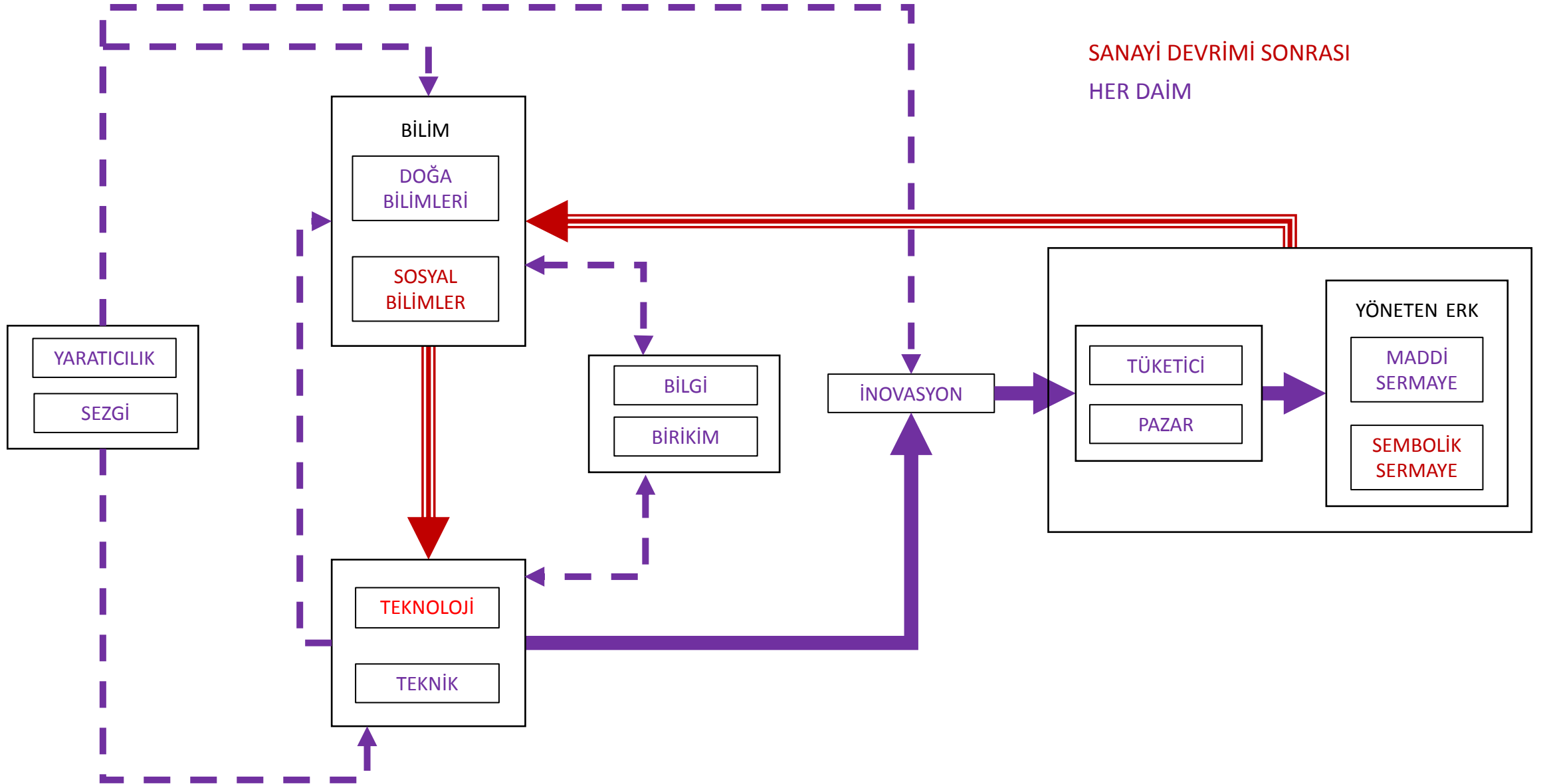

1750-1800

2000



BİLİM	KLASİK MEKANİK	TERMODİNAMİK	GELİŞTİRİLMİŞ TERMODİNAMİK
DOĞAYI ALGILAYIŞ	BİR MAKİNE	BİR SİSTEM	BİR SÜREÇ
İNSANIN ÜSTLENDİĞİ ROL	DOĞAYA HÜKMETMEK	DOĞAYI KABULLENMEK	DOĞAYLA UYUMLU OLMAK
MADDİ ÖLÇEK	PARA	ENERJİ	ENTROPİ
TEKNİK/TEKNOLOJİ KAVRAMI	ÜRETİM	İNŞA ETME YENİLİK	SÜRECİN YÖNETİM

0. TERMAL DENGİ
1. ENERJİNİN SAKINIMI
2. ENERJİNİN ERİŞİLEBİLİRLİĞİ VE ENTROPİ
3. MUTLAK SIFIR
4. OLMAYAN MADDE DÖNÜŞTÜRÜLEMEZ

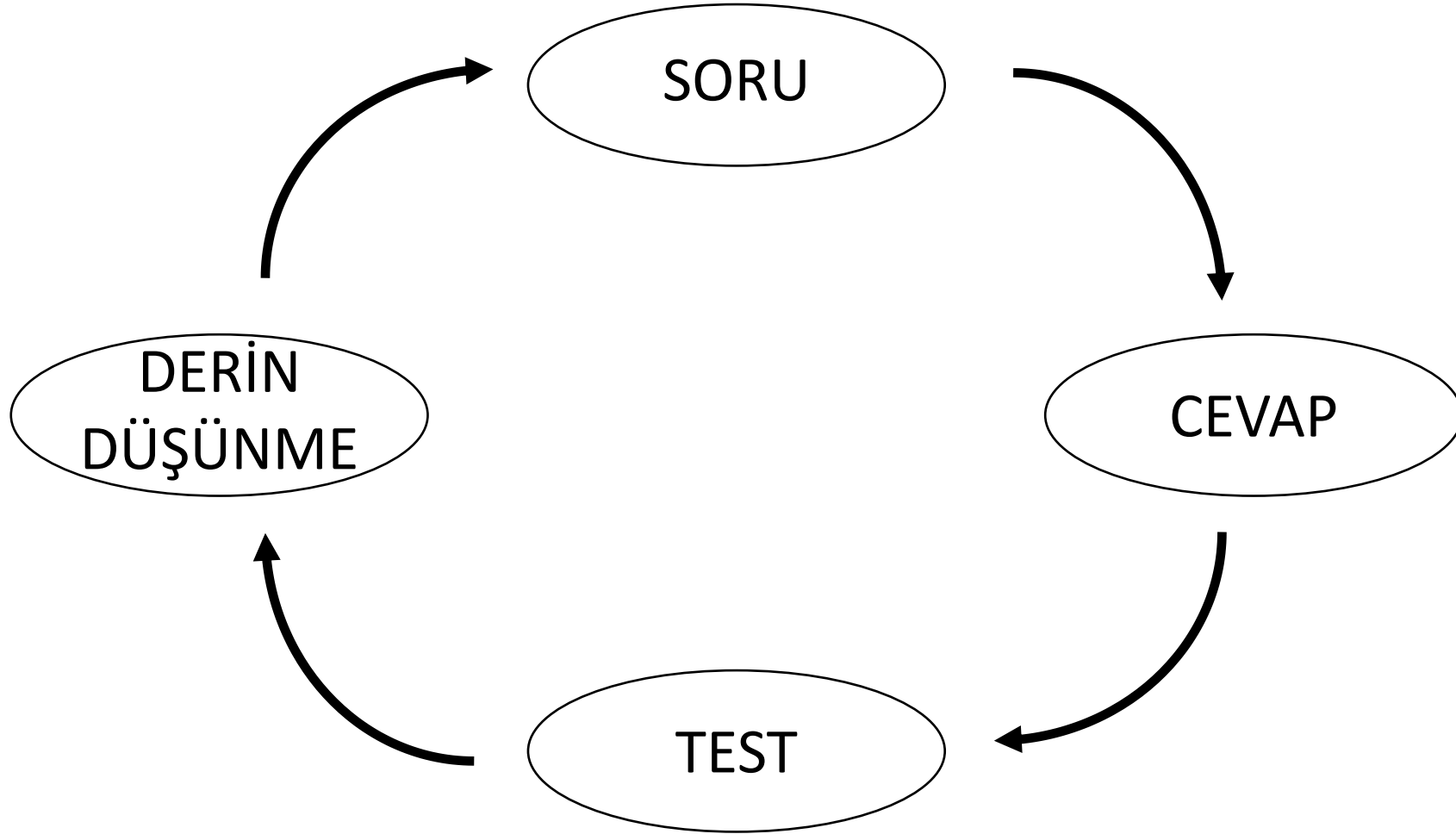

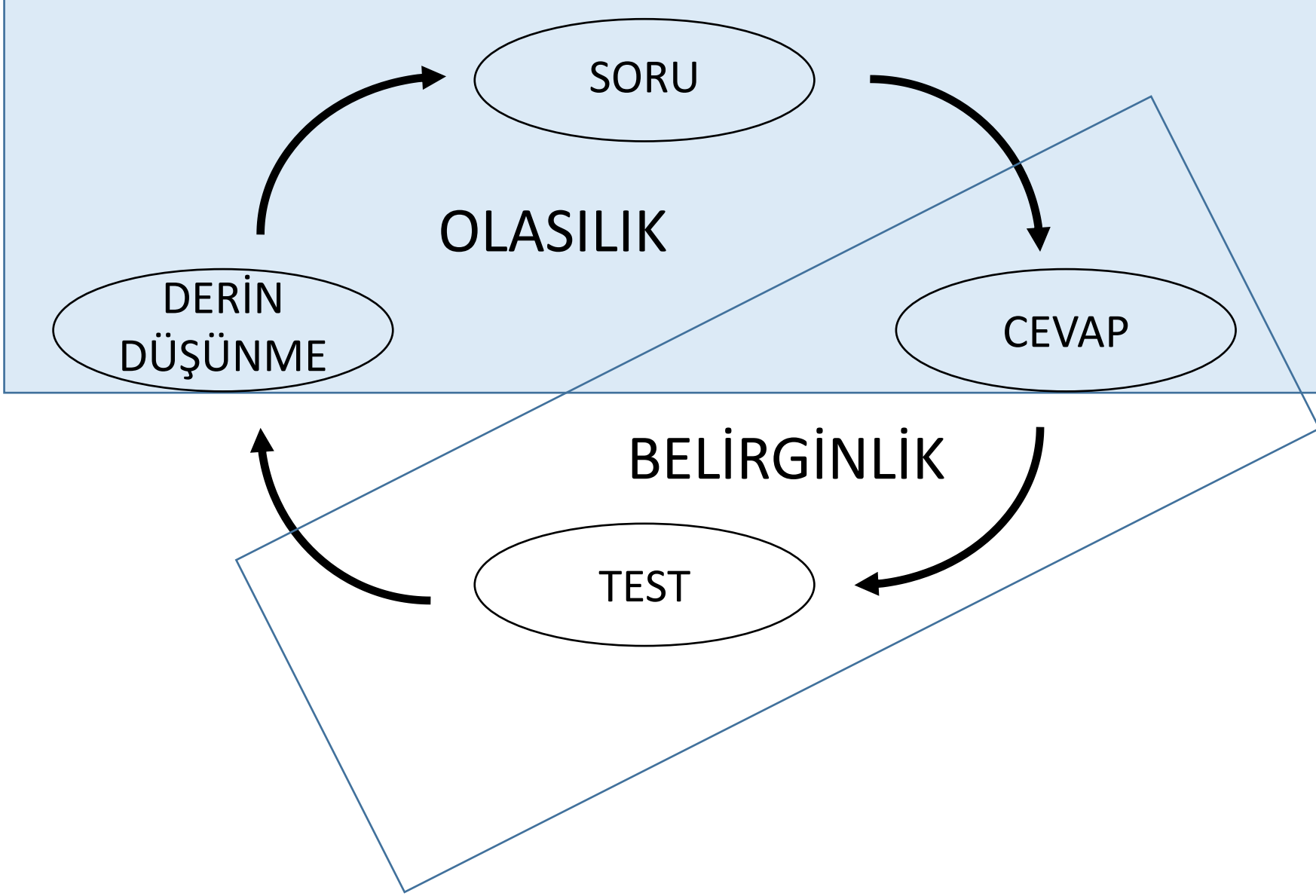

HİPOTEZ GELİŞTİRME

YARATICILIK
SORGULAMA

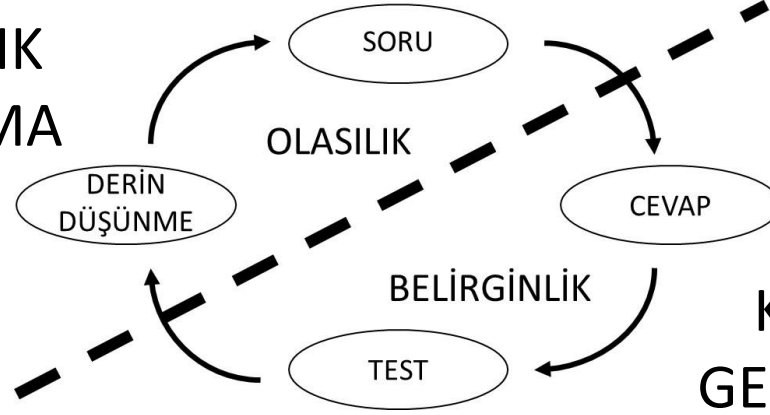

KURAM
GELİŞTİRME

DENEYLERLE
SAĞLAMA